



240W-300W Flood LED Luminaire



Date:..... Location:

Product:..... Project:.....

Quantity:..... Catalog#

FEATURES

- High efficiency 153Lm/Watt. Replacing old 500-1000w fixture
- IP65 RATED, Easy installation and maintenance
- Anti-corrosion and dust.
- 50,000 hours lifetime

SUITABLE APPLICATIONS

- Area Lighting
- Parking lot Auto Dealerships
- Shopping malls
- Building lighting
- Warehouse lighting
- Wall lighting



CONSTRUCTION:

Heavy die-cast aluminum alloy housing with bronze powder-coated finish. Aluminum reflector and UV resistant plastic lense.

ELECTRICAL:

Available as 120-277V input. -30°C to 50°C.

OPTICAL SYSTEM:

Lumileds 3030 LED chips. High quality transmission plastic optics.130*100° beam angle.

INSTALLATION&MOUNTING:

Angle-adjustable U Bracket mount for wall or square pole mounting.

WARRANTY:

5-year limited warranty. Actual performance may differ as a result of end-user environment and application.

PERFORMANCE

Model NO	Power Factor	Wattage	Voltage/CurrentInput		Light Efficiency	Kelvin Options
			120V	277V		
AST-FL13-240S2BT7SA1	0.9	240W	2.0A	0.86A	153LM/W	5700K
AST-FL13-300S2BT7SA1	0.9	300W	2.5A	1.08A	153LM/W	5700K

Flood LED Luminaire



Electric Characteristic

Specification/Model	AST-FL13-240S2BT7SA1	AST-FL13-300S2BT7SA1
LED Driver	UL LISTED Daermay DRIVER	
Input power	240W	300W
Lumens output	36720LM	45900LM
Efficiency	153LM/W	153LM/W
CRI	>72	>72
Color Temperature	5700K	5700K
Input voltage	120-277V/AC	120-277V/AC
Light distribution type	130*100D	130*100D
Working temperature	-30+50°C	-30+50°C
Junction temperature	<75°C	<75°C
lamps efficiency	≥90%	≥90%
Certificate	UL CUL DLC	UL CUL DLC
Equivalent	500-800W MH/HPS	600-1000W MH/HPS

DIMENSION

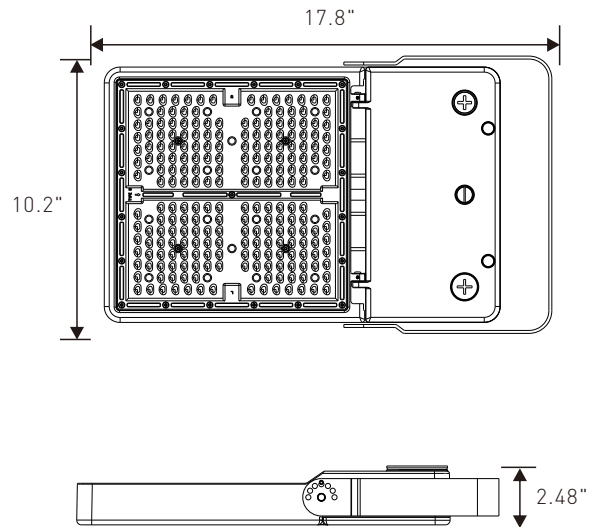

DISTRIBUTION DIAGRAM

AST-FL13-240S2BT7SA1

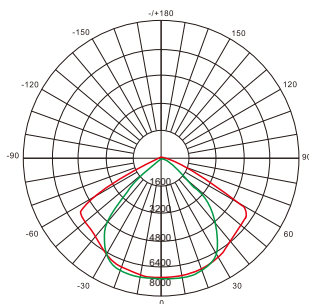

AVERAGE BEAM ANGLE[50%]: 111.9°

UNIT: CD
 Test Number: AST-FL13-240S2BT7SA1
 Lumens: 36720LM
 Test Number: 240W
 Test Number: 5700K

AST-FL13-300S2BT7SA1

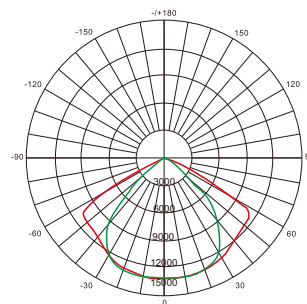

AVERAGE BEAM ANGLE[50%]: 112.9°

UNIT: CD
 Test Number: AST-FL13-300S2BT7SA1
 Lumens: 45900LM
 Test Number: 300W
 Test Number: 5000K

Instructions

Install the mount to the fixture, tighten the mount and install the screws. (Figure 1)

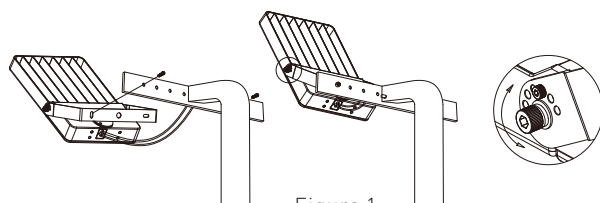

Figure 1

Loosen the angle to adjust the screw, after adjust to the angle that you need, then tighten the screws.